



2020 Residential Skylights Catalog

Residential Skylights and Sun Tunnel® Skylights



Table of Contents

SEE THE POSSIBILITIES

- 2 The No Leak Skylight
- 4 Skylight Innovations
- 5 VELUX ACTIVE with NETATMO
- 6 Go Solar Tax Credit
- 7 Light Control
- 8 Design by Rooms
- 22 Real Skylight Stories

SKYLIGHT INSTALLATION

- 36 Ceiling Types
- 37 Installation Methods
- 38 Flashing Systems
- 39 No Leak Warranty

OUR PRODUCTS

- 40 Skylights
- 50 Skylight Blinds
- 52 Custom Skylights
- 58 Sun Tunnel® Skylights
- 64 Flat Roof Skylights
- 70 Roof Windows
- 76 Architectural Skylights

TECHNICAL INFORMATION

- 82 Product Size Charts
- 85 Energy Star/Code of Compliance

Bringing light to life has been our passion for over 75 years.

So, why skylights?

In 1942 in the Danish city of Copenhagen, a young engineer came up with the idea to transform dark, empty attics into bright living spaces. This idea developed into the first handcrafted, no-leak roof window, which became the foundation for VELUX to grow into the number one skylight company in the world.

At VELUX, we believe homes full of light are homes that are full of life, that daylight is powerful and fresh air is invigorating. Together, they improve our general health and well-being, decrease our dependence on electricity, and give functionality back to our space. Able to fit just about anywhere in your home, VELUX skylights deliver unmatched quality, beautiful results, and a brighter home for your family.

We often ask, "Why skylights?" But with endless reasons to install one, the question becomes more, "Why not skylights?"

VELUX America LLC
450 Old Brickyard Road
PO Box 5001
Greenwood, SC 29648-5001
Phone: 1-800-888-3589
Fax: 1-864-943-2631



The No Leak Warranty

Our biggest promise that the skylights you add to your home will not leak.

VELUX's three patented layers of water protection work seamlessly to ensure no rain will leak into your home through your skylight.



These are not your parents' skylights.

Skylights that open. Skylights that won't leak. Skylights that lower your carbon footprint. Skylights that respond to the sound of your voice. Flat skylights, domed skylights, and skylights that turn into balconies. These are the kinds of skylights you'll find at VELUX. A passion for daylight, fresh air, and better living environments is what started our company over 75 years ago, and it's what drives us forward today.

A skylight that thinks for itself.

VELUX ACTIVE with NETATMO gives you the power to open and close your skylights and blinds with the sound of your voice or a touch of a button on your smartphone. What's more, with VELUX ACTIVE, your skylight learns your ideal home climate and works to match your comfort level by opening and closing automatically.

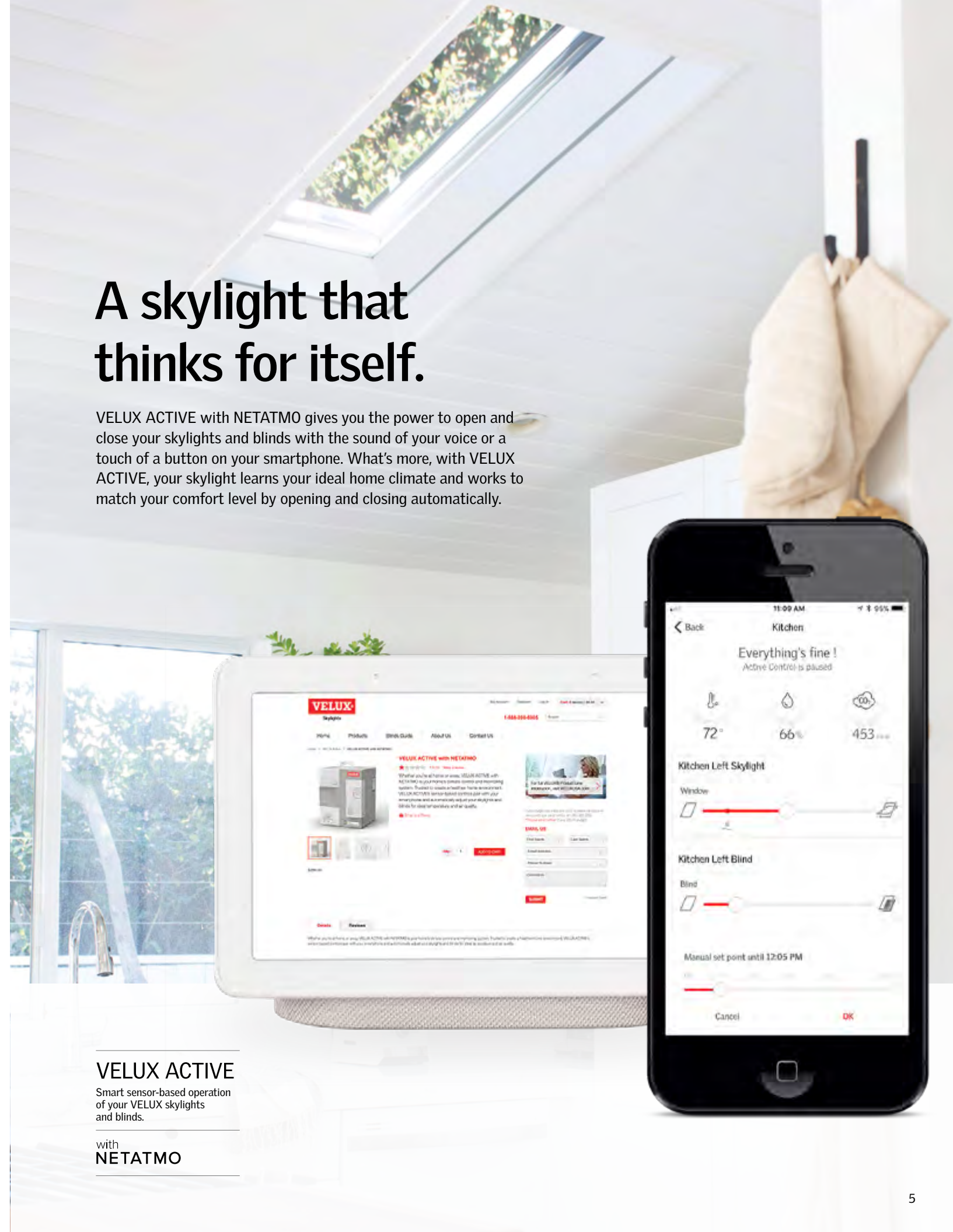

VELUX ACTIVE

Smart sensor-based operation of your VELUX skylights and blinds.

with
NETATMO



Now More Than Ever

It's time to Go Solar.

Go Solar by installing any of VELUX's solar-powered skylights, blinds, and accessories and receive a federal solar tax credit on the cost of both the product and installation. Look for the Go Solar logo on eligible products!

Complete Light Control

Add a pop of color to your ceiling while controlling the amount of light coming through your skylight with VELUX blinds! Shop our wide selection of room-darkening, light-filtering, and venetian blinds to match your home's style. And, don't forget to have them pre-installed in your skylight for free!

Get This Look



Kitchens



COOKING IN DAYLIGHT

A kitchen that's full of light and fresh air is a happy, healthy kitchen. When we start to look at kitchen upgrades, we tend to look around instead of up. Enhance your cooking area with natural light through skylights. It's one of the best ways to get the most out of the sights, smells, and even tastes created in your kitchen.

Get This Look



Bathrooms



TIME TO FRESHEN UP

The days of function-only bathrooms are behind us. It's time to create the luxurious, spa-like room you deserve. With a skylight, you can bring the outside in without sacrificing privacy and turn off the noisy bathroom fan in favor of cool, fresh air. Transform your bathroom into your own personal oasis - it's as simple as looking up!

Get This Look

Bedrooms



SLEEP UNDER THE STARS

Your bedroom is a place to recharge your body and mind, and skylights can help you make the most of it. Regular exposure to sunlight regulates your Circadian rhythm, which helps you sleep sounder and wake up feeling refreshed. When you open your bedroom up to the sky, you welcome in clear, natural light and a starry expanse at night for better sleep and more productive days.

Get This Look

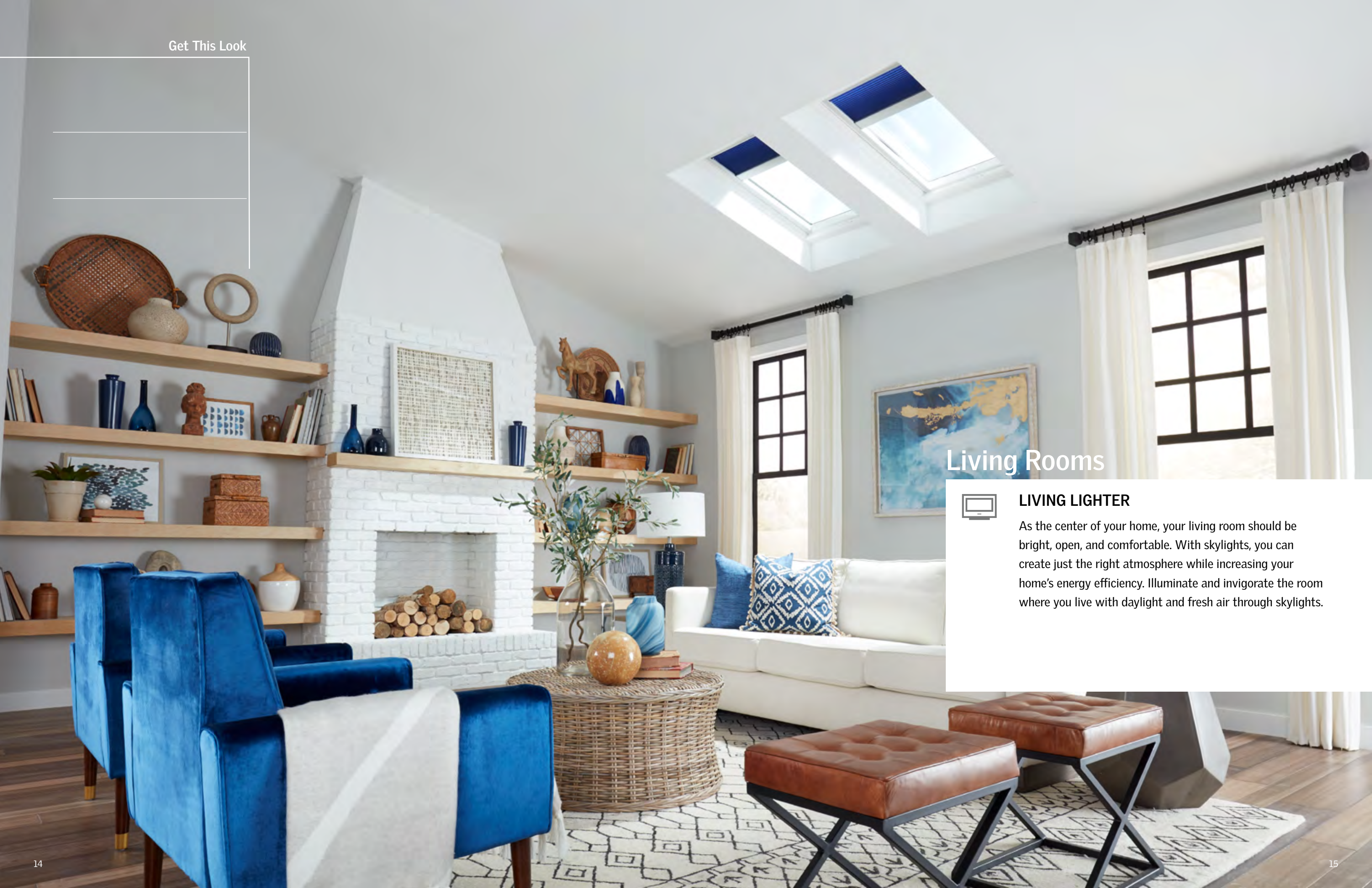

Living Rooms



LIVING LIGHTER

As the center of your home, your living room should be bright, open, and comfortable. With skylights, you can create just the right atmosphere while increasing your home's energy efficiency. Illuminate and invigorate the room where you live with daylight and fresh air through skylights.

Get This Look



Bonus Rooms



BONUS DAYLIGHT

Bonus rooms are notorious for being the dim, catch-all rooms, so fill yours with daylight! The best way to redesign your space into a multi-functional room the whole family will enjoy is with rich, natural light and crisp, fresh air. Skylights and roof windows can offer you more design possibilities than traditional windows to help transform your room in the roof.

Get This Look



Small Spaces



NATURAL LIGHT EVERYWHERE

Small spaces like hallways, closets, and laundry rooms can be hard to illuminate, especially with daylight. But with VELUX's innovative skylights, roof windows, and sun tunnels, you can bring in enough daylight and, in some places, fresh air to turn every corner of your home into something extraordinary.

Get This Look

Patios



A ROOM OF LIGHT

Patios are the best of both worlds: all the amenities of being inside with the atmosphere of the great outdoors.

Adding more daylight and fresh air with skylights is the next best step to upgrading your patio. And when you install skylights on your patio, they don't just affect that space; borrowed light spills into the surrounding interior rooms, helping brighten your entire home.



Daylight Renovations from Real Homeowners



Emily Henderson
Lake Arrowhead, California
Read more: stylebyemilyhenderson.com
Follow: @em_henderson

Natural Light from Above Makes This a Bedroom You'll Want To Wake Up In

Natural light from above was a key ingredient in the calm, Scandinavian master bedroom that interior design and style expert Emily Henderson created in her Lake Arrowhead mountain house. Sunlight from four VELUX No Leak Solar Powered "Fresh Air" skylights not only bathes the room in light, but brings out the color variations and grain details in the ceiling that is clad in reclaimed wood.

She can open the skylights to bring in cool, mountain air and the smell of pine trees, and fall to sleep gazing at the stars. When she wants to sleep in, she can block the light with remote-controlled room-darkening blinds.

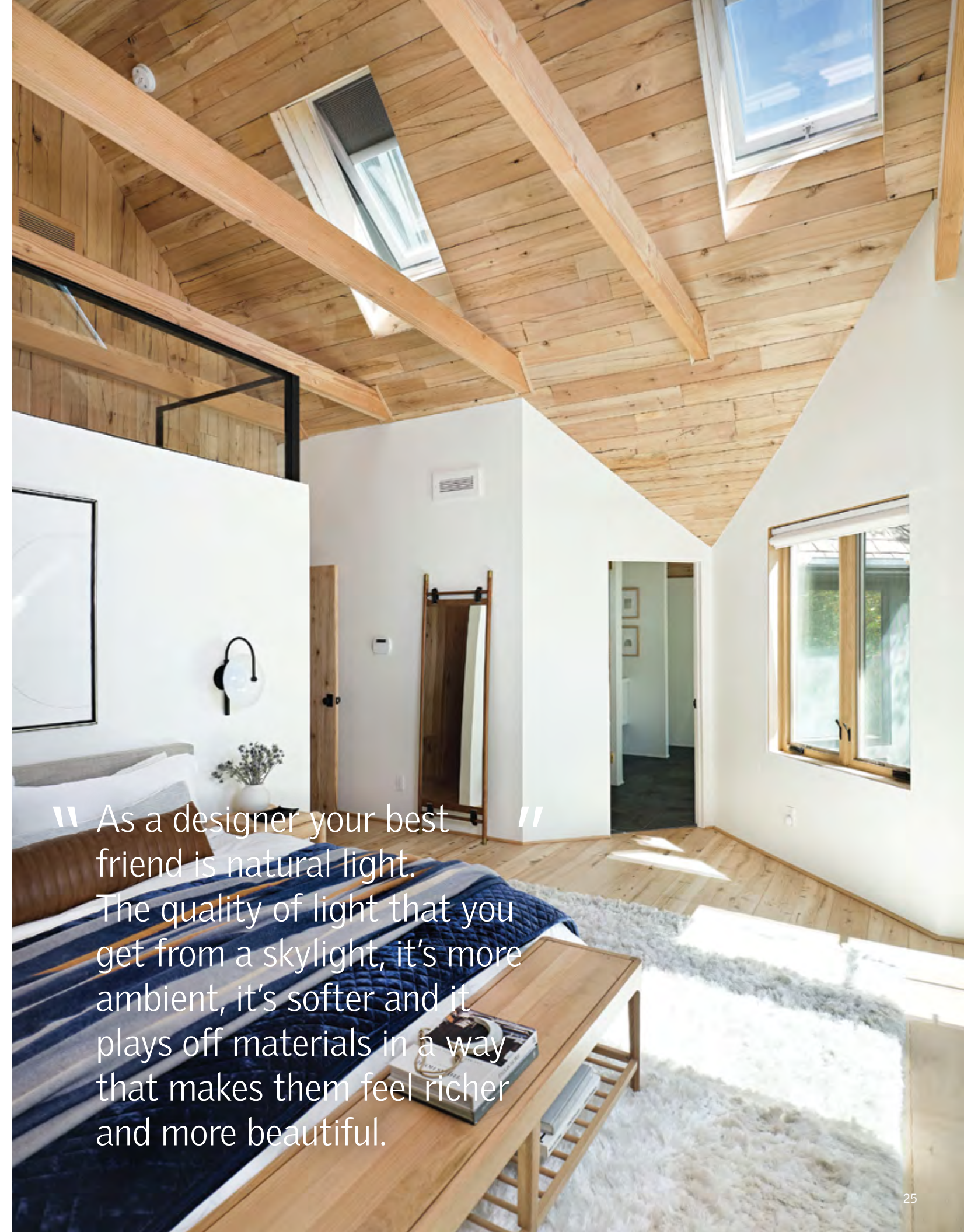

“ As a designer your best friend is natural light. The quality of light that you get from a skylight, it's more ambient, it's softer and it plays off materials in a way that makes them feel richer and more beautiful. ”



Tessa Tillett
Indianapolis, Indiana

It's All About the Light For This Galley Kitchen

Tessa Tillett bought her first home knowing she wanted a space that brought in plenty of natural light. As a recent graduate and a freelance photographer, having natural light in her home mattered. So, with a sledgehammer in hand, Tessa completely renovated her kitchen. She added new cabinets painted deep navy blue, hung a mustard yellow sliding door into the adjoining laundry room, installed butcher block counter tops, an oversized subway tile backsplash, and added in two VELUX skylights to help brighten the space and complement the new modern design.

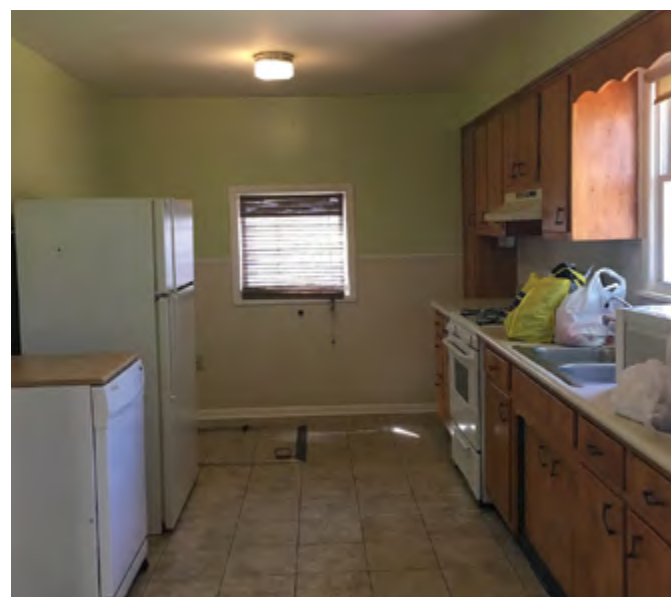

Before:
The rest of the house has 10-foot ceilings, but the kitchen had only 8-foot ceilings with two tiny windows. Tessa describes it as a dark space and an area she knew she wanted to spend her time renovating.

“ I’m a photographer and I’m obsessed with light and natural light especially. It was important for me to have tons of natural light coming in. ”





Brian Patrick Flynn
Atlanta, Georgia
Follow: @bpatrickflynn

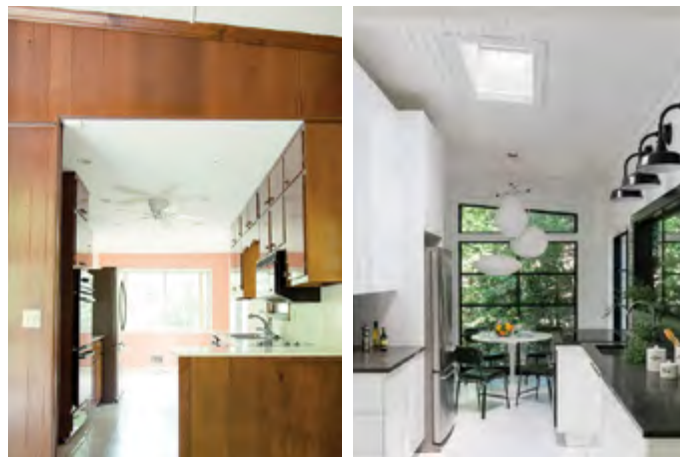

Flynncentury Whole Home Modern Makeover

When Brian Patrick Flynn first moved into his mid-century modern ranch home, he fell in love with the mature landscaping and tree canopies outside. On the inside, however, he faced separate, privatized spaces and super dark areas. Always the designer, Brian decided to look up and focus on the home's fifth wall as much as possible. The ceilings gave him the possibility to bring in much-needed natural light, as well as high-energy hues and colors. With VELUX Skylights and Sun Tunnels®, Brian was able to lighten and brighten this diamond in the rough.

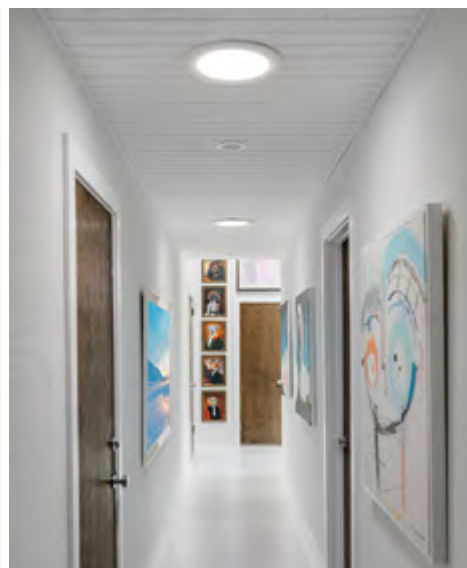

“I decided to focus on the fifth wall as much as possible, something I’d been doing since starting my career as a self-taught designer (I cannot stand a blank, flat white ceiling).”



“It’s nice because we live on a busy street and so we can close the window curtains and feel private and still have the natural light.”



Gorczynski Family
Lawrence Township, New Jersey

Natural Light Transforms A New Jersey’s Family Living Room

After moving into their home in Southern New Jersey almost two years ago, Katie and Bryan Gorczynski faced a conundrum when it came to their dark living room. Even after swapping out a solid door for a sunshine yellow one with windows, painting the living room white, and switching the furniture around, this northwest-facing living room still felt dark. In April of 2019, a VELUX 5-Star Skylight Specialist installed two skylights in the room and now the space is bathed in natural light, even on an overcast day.

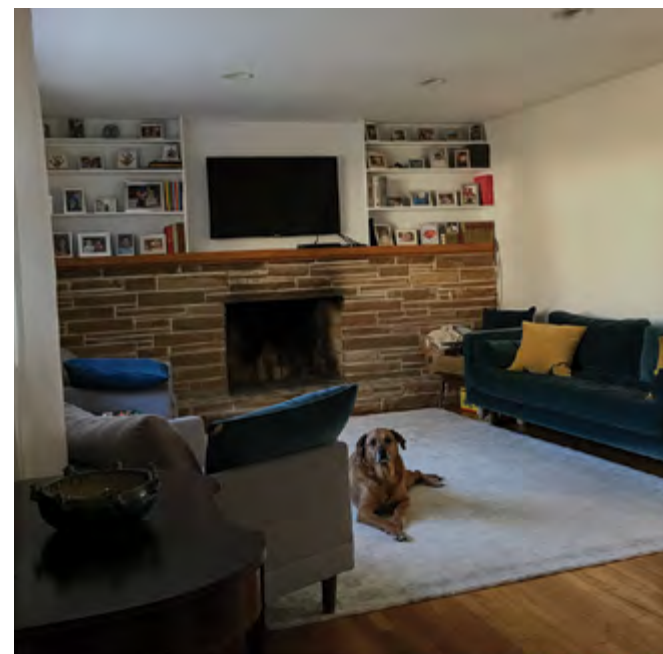

Before:

This dark living room had a large picture window with a Japanese maple tree out front that blocked most of the light coming into the room. The family adjusted the furniture layout to try to make the space feel more open. “We put the couch against the wall, even though we wanted it opposite the TV,” said Katie. “When we put it across from the TV the room felt very closed off.”



“ At first we were just awestruck at how much both structural and literal beauty it brought into the space. But after living with it for a few months we now know its true impact.”



Shavonda Gardner
Sacramento, California
Read more: sgstyleblog.com
Follow: [@sgardnerstyle](https://www.instagram.com/sgardnerstyle)

Light and Air is a Game Changer for this Small Bathroom

Interior designer Shavonda Gardner and her family ditched their cookie-cutter, builder-grade large home for a little cottage bungalow in Sacramento, California. They were on a downsizing journey, so when it came time to remodel the home's only bathroom, Shavonda knew she would have to make bold design choices. She opted to add a VELUX Solar Powered "Fresh Air" Skylight to the bathroom to bring in ample amounts of natural light and fresh air, while allowing her to still push the envelope of design.

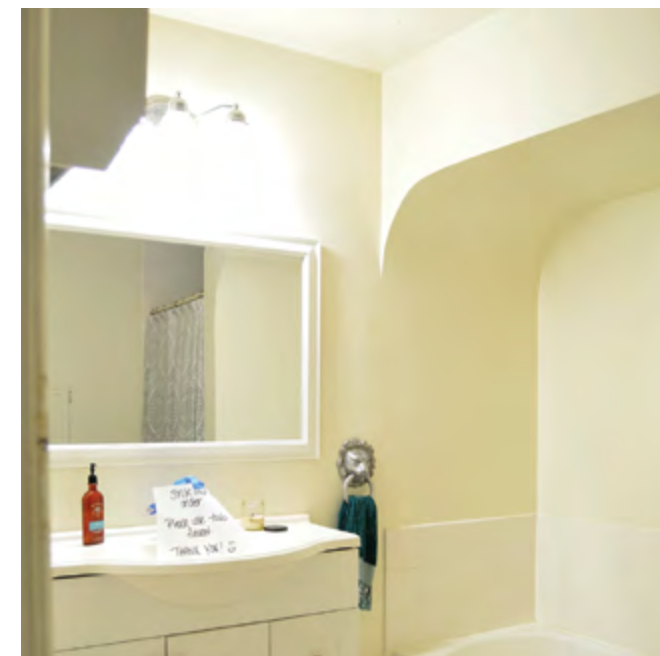

Before:
The home featured just one bathroom, which was an interior room with no chance of having windows added. Shavonda describes the bathroom as being dark and muggy with even a claustrophobic feeling due to the lack of outside light.



Kristen Burns and Raeann Bourscheid
Salt Lake City, Utah

Bringing Nature Inside This Master Bedroom

Before the room makeover, Kristen and Raeann's dark bedroom had only one small window, and it seemed like the couple just hadn't had time to get to decorating it. But in December 2018 when Kristen was diagnosed with a rare form of cancer called cholangiocarcinoma, Raeann knew Kristen needed a space that could bring her peace and happiness. The couple won a complete room makeover when they entered the VELUX Brighten Up Any Space Design Giveaway with interior design and style expert, Emily Henderson. The finished project: a haven that brings the best of nature in.



Before:
A dark space with a
small window on one
side of the room.



"I really wanted Kristen to be able to see outside, to see the sky and the stars and feel like she had nature inside, so if she had to spend the whole day in bed she would still feel good."

A Skylight for Every Ceiling

Flat, Vaulted, Sun Tunnel®

Have you considered installing a skylight then looked up at your flat ceiling and thought that there's just no way? You're not alone! One of the most common misconceptions about skylights is that they can only be installed in homes with vaulted ceilings. But we're here to tell you that's not the case.



Flat Ceiling



If you have flat ceilings, once your skylight is set outside, your installer will construct a drywall light shaft inside. This shaft directs daylight to the room below while hiding the attic space between your ceiling and roof.

Vaulted Ceiling



The advantage to vaulted ceilings during skylight installation is that without attic space between the roof and your home's interior, there's no need for a light shaft. So, once your skylight is installed, the work's all done.

Sun Tunnel®



The Sun Tunnel® Skylight's highly reflective and cylinder shape fits between ceiling supports, allowing light to travel from your roof down to the space below uninhibited.

3 Types of Installation

Deck-Mounted, Curb-Mounted, Self-Flashed

When it comes to skylights, there are three different types of installation methods. To know which installation is right for a home, a skylight installer or roofer will evaluate the home's roof pitch, roof material, ceiling type, and whether this is a replacement job or a new cut-in. But whatever the method, you're installing the same great skylight that brings in plenty of natural light and fresh air!

1

Deck-Mounted Skylights

Deck-mounted skylights allow for your skylight to have a low profile on your roof and create an energy-efficient installation. With this installation, your skylight is nailed directly to the roof-deck. Deck-mounted skylights are ideal for new construction homes or for brand new cut-in skylights.



2

Curb-Mounted Skylights

Curb-mounted skylights are the most common installation preference in low-pitch or flat-roof situations. The "curb" is a frame built mostly of two-by-fours that are attached to the roof. The skylight is then installed on top of the curb. You can imagine it as a shoebox: the curb is the box and the skylight is the top.

3

Self-Flashed Skylights

Self-flashed skylights differ from both deck- and curb-mounted skylights because their curb and flashing are built into the skylight. No extra flashing kit is needed. The skylight sits directly over the rough opening in the roof deck and is then sealed.



Flashing Systems

Deck-Mounted, Curb-Mounted

VELUX Skylight Flashing Kits are a crucial part of our complete system designed to shed water without relying on sealants that can break down over time. No matter the scope of your project, we offer a variety of skylight flashing systems to ensure a weather-tight fit for virtually all roof types and slopes so you can easily install the skylight of your dreams.

Deck-Mounted Flashing Systems

Each of our deck-mounted flashing systems includes a pre-attached deck seal, adhesive underlayment, and engineered flashing. They attach directly to your roof deck and interweave with the roofing material to ensure your skylight won't leak.



Shingles/Shakes - EDL



Tile Roofing - EDW

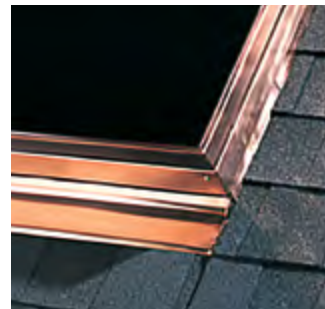

Copper Cladding & Flashing



Metal Roofing - EDM



Combi Applications

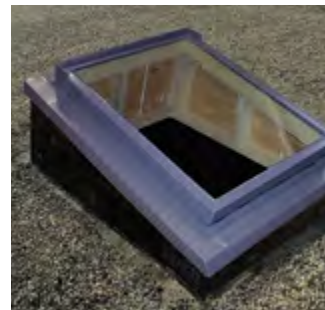

Biepack Flashing - ECB

Curb-Mounted Flashing Systems

VELUX curb-mounted flashing systems come with a pre-attached skylight gasket, which provides a tight seal between the site-built curb and skylight. When combined with an included adhesive underlayment and engineered flashing, they create a seal to ensure no water leaks around your skylight.

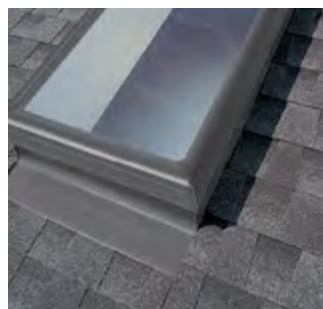

Shingles/Shakes - ECL



Tile Roofing - ECW

No Leak Warranty

3 Layers of Protection



The No Leak Promise is our guarantee to you that the VELUX skylights installed in your home will not leak. We're able to make and keep this promise with a 10-year installation warranty thanks to our patented three layers of water protection on our deck- and curb-mounted skylights.

- 1 Pre-Attached Seal**
Pre-attached deck seal (deck-mounted) or gasket (curb-mounted) provides a tight seal for leak-proof installation.
- 2 Adhesive Underlayment**
Adhesive underlayment for secondary water protection against the harshest weather conditions.
- 3 Engineered Flashing**
Engineered flashing for easy installation and primary water protection.²

Rest easily beneath your skylight knowing that, while it lets in abundant sunlight and fresh air, it will never let in rain.

Skylights

For a sleek, classic look that blends seamlessly into any roofline, VELUX Skylights open your home to a world of brighter days. Available in fixed and venting options and designed not to leak, these skylights are perfect for creating a spacious home filled with natural light and fresh air.





Skylights



- Solar-powered to effortlessly open and close your skylight without electricity, circulating fresh air throughout your home
- Acoustic rain sensor closes skylight at the first sign of rain
- Make our signature skylight even better by pairing it with VELUX ACTIVE, giving you the freedom to open and close your skylights from your phone or automatically adjust to match your ideal indoor climate
- Flashing kit required for No Leak Warranty²
- Many standard sizes available

 14° - 85°
 3:12 - 137:12
 VSS, EVMS
 Roof Pitch

 0° - 60°
 0:12 - 20:12
 VCS Roof Pitch

 Insect screen
 included



 Pre-Installed and
 special order blinds
 available³

Federal
**SOLAR
 TAX CREDIT**
 With Go Solar¹

Skylights



- Quietly opens and closes to circulate fresh air throughout your home, giving you the feel of a cool breeze at the touch of a button
- Acoustic rain sensor closes skylight at the first sign of rain
- Seamlessly pairs with any VELUX blinds for optimal light control — select blinds can be pre-installed for free
- Pairs with VELUX ACTIVE: open and close your skylights from your phone or have it automatically adjust them to match your ideal indoor climate
- Flashing kit required for No Leak Warranty²
- Many standard sizes available

14° - 85°
3:12 - 137:12
VSE Roof Pitch

0° - 60°
0:12 - 20:12
VCE Roof Pitch



Insect screen
included

Pre-installed and
special order blinds
available

Skylights



- Effortlessly open and close skylight with a smooth operator hook
- Equipped with insect screen to prevent pests
- Seamlessly pairs with any VELUX blinds for optimal light control — select blinds can be pre-installed for free
- Flashing kit required for No Leak Warranty²
- Many standard sizes available

 14° - 85°
 3:12 - 137:12
 VS and EV
 Roof Pitch

 0° - 60°
 0:12 - 20:12
 VCM Roof Pitch

 Insect screen
 included



 Pre-installed and
 special order blinds
 available³

Federal
SOLAR
TAX CREDIT
 With Go Solar¹

Skylights



- Clean exterior profile provides natural light without obstructing roofline
- Versatile sizing allows for greater flexibility in positioning options
- Seamlessly pairs with any VELUX blinds for optimal light control — select blinds can be pre-installed for free
- Flashing kit required for No Leak Warranty²
- Many standard sizes available

 14° - 60°
 3:12 - 20:12
 QPF
 Roof Pitch

 14° - 85°
 3:12 - 137:12
 FS and EF
 Roof Pitch

 0° - 60°
 0:12 - 20:12
 FCM Roof Pitch

 Pre-installed and
 special order blinds
 available³

Federal
SOLAR
TAX CREDIT
 With Go Solar¹

Skylights

Forget the hassle! Have your blinds pre-installed for FREE when included with your skylight purchase. Offer not available for special order blinds.

Light-Filtering, Single-Pleated Blinds - Solar-Powered or Manual



Room-Darkening, Double-Pleated Blinds - Solar-Powered or Manual

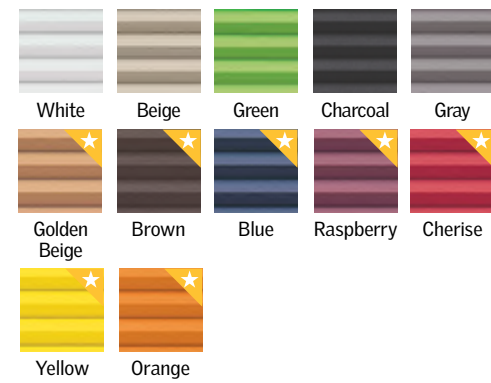

Venetian Blinds - Manual

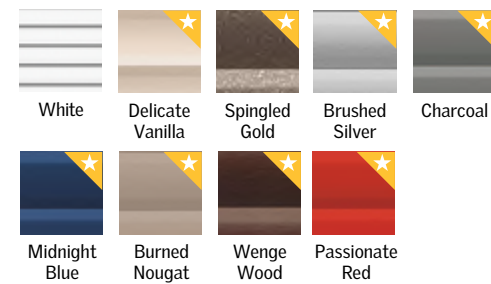

 Special order blinds ship separately from your skylight.



Custom-Sized Skylights

Your skylights, your way. When standard-sized skylights won't fit your project, we offer custom-sized skylights. Available in fixed and venting options and in measurements up to 32 square feet, VELUX Custom-Sized Skylights are available in the size and shape you need to create the perfect look for your home.



Custom-Sized Skylights

Venting Skylights



Available in solar-powered (EVMS) and manual (EV).

Custom Venting Skylights

- Solar and manual operation models to fit every household
- Integrated Ultraseal Flashing for a leak-proof performance
- Acoustic rain sensor closes skylight at the first sign of rain

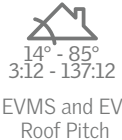

14° - 85°
3:12 - 137:12
EVMS and EV
Roof Pitch

Federal
SOLAR
TAX CREDIT

With Go Solar¹

Custom-Sized Skylights

Fixed Skylights



GSM CUSTOM SIZES UP TO **10** FT WIDE

Available in curb-mounted (FCM), self-flashed (EF), and SkyMax (GSM).

- Clean exterior profile provides natural light without obstructing roofline
- Versatile sizing allows for greater flexibility in positioning options
- GSM Skylight covers areas up to 32 square feet in any dimensions



1° - 60°
1/4:12 - 20:12
GSM Roof Pitch



14° - 85°
3:12 - 137:12
EF Roof Pitch

0° - 60°
0:12 - 20:12
FCM Roof Pitch

Sun Tunnel[®] Skylights

Every room in your home deserves to be filled with natural light – even those in the center of your home. Unlike traditional windows and skylights, VELUX Sun Tunnel[®] Skylights can be installed virtually anywhere in your house in a single afternoon and at a fraction of the cost.

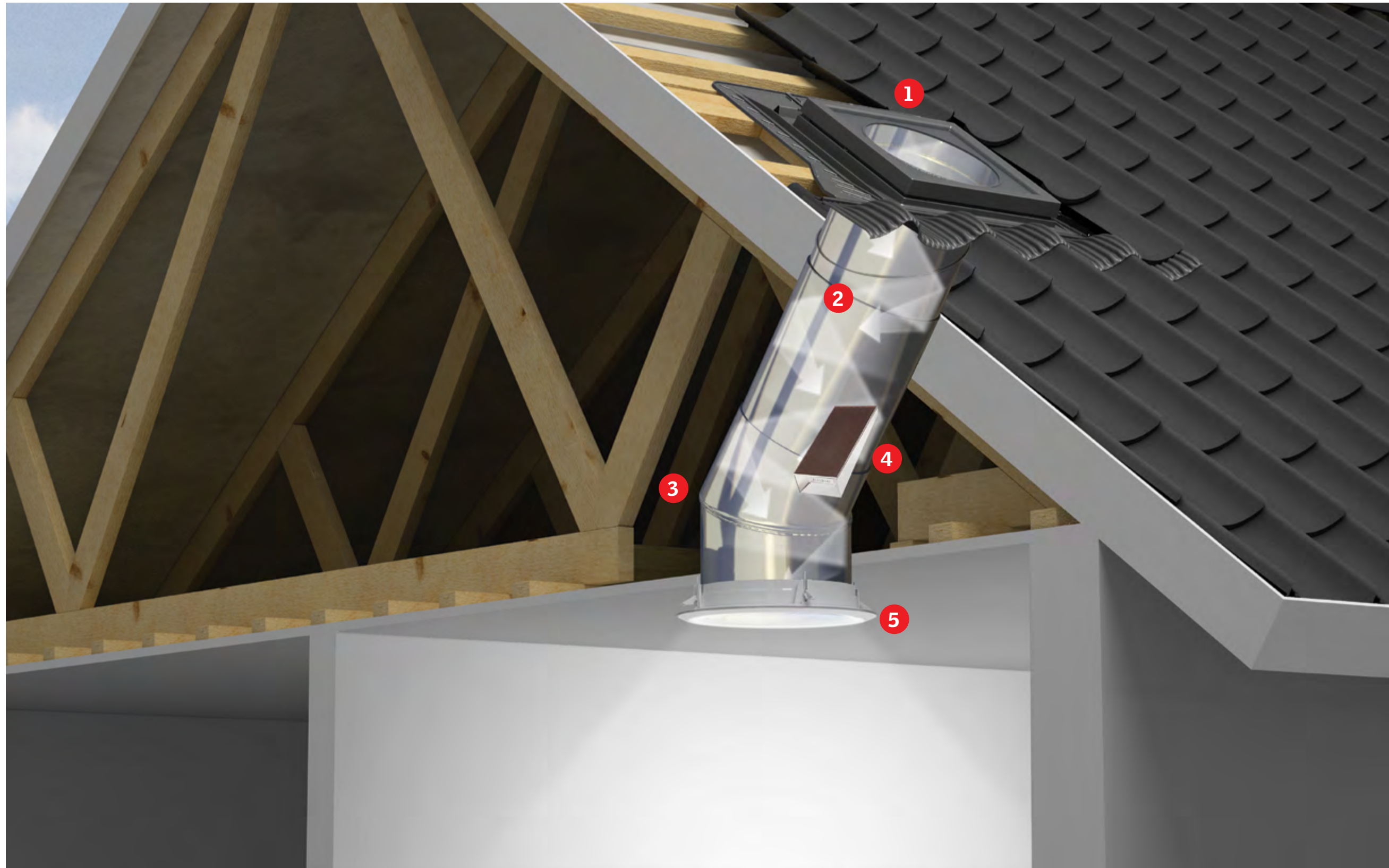
- 1 Low-Profile Appearance:** Features an extremely low-profile flat glass (the only one of its kind) that allows it to blend seamlessly into your roofline.
- 2 Highly Reflective Tunnel:** Delivers maximum sunshine from the roof to your ceiling due to the reflective material of the tunnel.
- 3 Versatile Design:** Fits between rafters and around other obstructions in your attic, allowing the sun tunnel to be one of VELUX's most versatile skylights.
- 4 Additional Lighting:** Whether you're looking for a moon-like nighttime glow or want to flip a switch for light at any time, add any of our lighting control options to your sun tunnel. For additional light, day and night, opt for the Solar Night Light, Daylight Controller, or Electric Light kit.
- 5 Ceiling Ring and Frosted Diffuser:** Add a decorative, modern flare to your room while softly diffusing the natural light pouring in.



Sun Tunnel® Skylights



- Versatile, highly reflective tunnel carries light from the roof to the space below uninhibited
- Compatible with multiple diffuser options to finish the look of a room
- One of our fastest, least expensive ways to transform a room with daylight
- Go Solar with the Solar Night Light for rigid tunnels to receive a federal tax credit on product and installation¹
- For all Sun Tunnel® Skylight options

14° - 60°
3:12 - 20:12
TGF, TGR, TMF,
TMR, and TLR
Roof Pitch

0° - 60°
0:12 - 7:12
TCR Roof Pitch

ZTZ 213
Solar Night Light

Federal
**SOLAR
TAX CREDIT**
With Go Solar¹

Flat Roof Skylights

Designed for homes with flat or low-pitch roofs, VELUX's line of Flat Roof Skylights transform and improve any space with daylight. The innovative design of these skylights lets in more daylight, easily drains rainwater, and stands out as a modern addition to roof surfaces.



Flat Roof Skylights



- Designed for homes with flat or low-pitch roofs
- Features maintenance-free PVC curb with insulation and toughened glass to be virtually impervious to damage
- Innovative curve shape lets rainwater drain off easily
- Protective cover reduces the likelihood of condensation and minimizes outdoor sounds
- CXP manually opens up to 60° to allow easy roof access

0° - 15°
0:12 - 3:12
CFP and CXP
Roof Pitch

Flat Roof Skylights



- FCM features a low-profile flat glass to blend seamlessly into your roofline
- Visually expands room with natural light from above
- Go Solar with accompanying accessory pieces (Solar Night Light for Sun Tunnel® or Solar-Powered Blinds for Fixed Curb-Mounted Skylights) to receive a federal tax credit on product and installation¹

Factory-installed accessory pieces may need to be added.



0° - 60°
0:12 - 20:12
FCM Roof Pitch



0° - 60°
0:12 - 7:12
TCR Roof Pitch



ZTZ 213
Solar Night Light

Federal
**SOLAR
TAX CREDIT**
With Go Solar¹

Roof Windows

The sky is the limit with VELUX Roof Windows! These in-reach windows manually open to let fresh air flow in and maximize the amount of natural daylight in your home. The perfect choice for loft conversions and attic spaces, roof windows allow you to enjoy panoramic views while increasing your home's energy efficiency and natural ventilation.





Roof Windows



- Greatly increase the amount of natural light and fresh air in your rooms
- Sleek outer appearance blends in with your roofline
- Top-Hinged features a convenient bottom operation for in-reach applications
- Roof Access Window offers easy roof access for repairs, maintenance, emergency, and egress
- Roof Access Window features a locking device to keep window open so it won't fall shut

All cladding components are included in the VELUX flashing box. If VELUX flashing is not purchased, cladding must be ordered.

15° - 55°
3:12 - 17:12
GPU Roof Pitch

15° - 85°
3:12 - 17:12
GXU Roof Pitch

Special order blinds available

Roof Windows



- Center Pivot top control bar can be pulled once for background ventilation, twice to open and rotates 180°
- Low installation of Center Pivot allows for more flexibility and better views
- CABRIO™ transforms from roof window to balcony in seconds to enjoy any time
- Top half of CABRIO™ opens to become a roof window, open both halves for balcony
- CABRIO™ balcony fits flush with the roof when closed

All cladding components are included in the VELUX flashing box. If VELUX flashing is not purchased, cladding must be ordered.



15° - 90°
3:12 - 90°

GGU Roof Pitch



35° - 53°
8.4:12 - 15:12

GDL Roof Pitch



Special order blinds available

Architectural Skylights

Consisting of stunning pyramid and modular systems, as well as impressive pitched roof applications, the VELUX Architectural Skylight line offers a dramatic yet stylish way to incorporate more daylight into your home. Providing breathtaking sky views, the Architectural Skylights are completely customizable to create just the right look for your home.



Architectural Skylights



- Create spectacular daylighting applications with unlimited design capabilities
- Lightweight, metal-framed skylights capable of spanning up to 40 feet wide
- Insulated glass panels help control heat gain and loss in all types of weather
- Available in a wide variety of high-performance glass and finish options

Architectural Skylights



- Complete system made of multiple skylights with a self-supporting structural system that does not require rafters or beams for support
- Prefabricated components ensure a quality build, 100% water tightness, and fast, easy installation
- Available in a variety of configurations with both venting and fixed modular skylights
- Includes electronic control system with wind and rain sensor

Skylight Sizes

		A06	C01	C04	C06	C08	C12	D26	D06	M02	M04	M06	M08	S01	S06
Rough Opening (W-in. x H-in.)	14 1/2 x 45 3/4	21 x 26 7/8	21 x 37 7/8	21 x 45 3/4	21 x 54 7/16	21 x 70 1/4	22 1/2 x 22 15/16	22 1/2 x 45 3/4	30 1/16 x 30	30 1/16 x 37 7/8	30 1/16 x 45 3/4	30 1/16 x 54 7/16	44 1/4 x 26 7/8	44 1/4 x 45 3/4	
VSS / VSE Solar / Electric		•	•	•	•					•	•	•	•	•	
VS Manual		•	•	•	•					•	•	•	•	•	
FS Fixed	•	•	•	•	•	•	•	•	•	•	•	•	•	•	

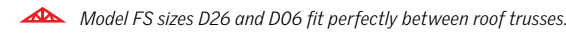

		1430	1446	2222	2230	2234	2246	2270	3030	3046	3055	3434	3446	4622	4646
Outside Curb (W-in. x H-in.)	17 1/2 x 33 1/2	17 1/2 x 49 1/2	25 1/2 x 25 1/2	25 1/2 x 33 1/2	25 1/2 x 37 1/2	25 1/2 x 49 1/2	25 1/2 x 49 1/2	25 1/2 x 73 1/2	33 1/2 x 33 1/2	33 1/2 x 49 1/2	33 1/2 x 58 1/2	37 1/2 x 37 1/2	37 1/2 x 49 1/2	49 1/2 x 25 1/2	49 1/2 x 49 1/2
Max. Skylight Clearance (W-in. x H-in.)	18 5/8 x 34 5/8	18 5/8 x 50 5/8	26 5/8 x 26 5/8	26 5/8 x 34 5/8	26 5/8 x 38 5/8	26 5/8 x 50 5/8	26 5/8 x 50 5/8	26 5/8 x 74 5/8	34 5/8 x 34 5/8	34 5/8 x 50 5/8	34 5/8 x 59 5/8	38 5/8 x 38 5/8	38 5/8 x 50 5/8	50 5/8 x 26 5/8	50 5/8 x 50 5/8
VCS / VCE Solar / Electric			•	•	•	•	•	•	•	•		•			•
VCM Manual			•	•	•	•	•	•	•	•		•		•	•
FCM Fixed	•	•	•	•	•	•	•	•	•	•	•	•	•	•	•

FCM custom sizes available



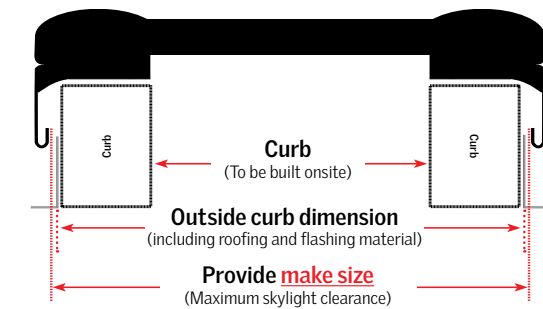

FCM Custom Sizes



Length	Width	Production Time
18 3/4 x 72	18 3/4 to 50 3/4	8-14 days
72 1/4 to 76 1/2	18 3/4 to 50 3/4	20 days or less





We require maximum skylight clearance dimensions in 1/4" increments (0, 1/4, 1/2, 3/4) for width and height.
 Custom size flashing kits and blinds are not available.
 Some specialty glass options require longer lead times.

Skylight Sizes

		1430	1446	2222	2230	2238	2246	2254	3030	3046	3054	4646
Rough Opening (W-in. x H-in.)	14 1/2 x 30 1/2	14 1/2 x 46 1/2	22 1/2 x 22 1/2	22 1/2 x 30 1/2	22 1/2 x 38 1/2	22 1/2 x 46 1/2	22 1/2 x 54 1/2	30 1/2 x 30 1/2	30 1/2 x 46 1/2	30 1/2 x 54 1/2	46 1/2 x 46 1/2	
EV Manual				•	•	•	•	•	•	•	•	•
EF Fixed		•	•	•	•	•	•	•	•	•	•	•
QPF Fixed				•	•				•	•		•

EVMS, EV, EF custom sizes available





		6060	6090	8080	90120	100100	120120	150150
Rough Opening (W-in. x H-in.)	23 5/8 x 23 5/8	23 5/8 x 35 7/16	31 1/2 x 31 1/2	35 7/16 x 47 1/4	39 3/8 x 39 3/8	47 1/4 x 47 1/4	59 x 59	
CFP Fixed		•	•	•	•		•	
CXP Exit					•	•	•	

		CK02	CK04	CK06	FK04	FK06	FK08	MK04	MK06	MK08	MK10	PK06	PK08	PK10	SK06	SK08	UK04	UK08
Rough Opening (W-in. x H-in.)	22 1/8 x 31 1/8	22 1/8 x 39	22 1/8 x 46 7/8	26 1/2 x 39	26 1/2 x 46 7/8	26 1/2 x 55 1/2	31 1/4 x 39	31 1/4 x 46 7/8	31 1/4 x 55 1/2	31 1/4 x 63 1/2	37 3/8 x 46 7/8	37 3/8 x 55 1/2	37 3/8 x 63 1/2	45 3/8 x 46 7/8	45 3/8 x 55 1/2	53 1/4 x 39	53 1/4 x 55 1/2	
GPU Top-Hinged			•	•				•	♦	♦				♦	♦			♦
GGU Center-Pivot		•	•	•	•	•	•	•	•	•	•	•	•	•	•	•	•	•
GXU Roof-Access				•		♦												

♦ Satisfy egress requirements

		PK19
Model Cabrio		
Rough Opening (W-in. x H-in.)	39 3/8 x 101	

Skylight Sizes

	Model TLR	Model TCR	Model TMR		Model TGR		Model TMF	Model TGF	
									
	14° - 60° 3:12 - 20:12	0° - 60° 0:12 - 20:12	14° - 60° 3:12 - 20:12	14° - 60° 3:12 - 20:12	14° - 60° 3:12 - 20:12	14° - 60° 3:12 - 20:12	14° - 60° 3:12 - 20:12	14° - 60° 3:12 - 20:12	14° - 60° 3:12 - 20:12
	014	014	010	014	010	014	014	014	022
Rough Opening (ceiling)	14 3/4	14 3/4	10 3/4	14 3/4	10 3/4	14 3/4	14 3/4	14 3/4	22 3/4
Rough Opening (roof deck)	14 1/2 x 17 3/4	16 3/4 x 16 3/4	12 1/2 x 16	14 1/2 x 20	14 1/2 x 16	14 1/2 x 18	14 1/2 x 20	14 1/2 x 18	22 1/2 x 26
Tunnel Length with Kit (ft.)	4	4	4	4	4	4	8	8	8
Maximum Recommended Install Length (ft.)	30	30	20	30	20	30	8	8	12

VELUX rigorously tests the materials of our skylights so that you can rest assured the products you install in your home are safe.

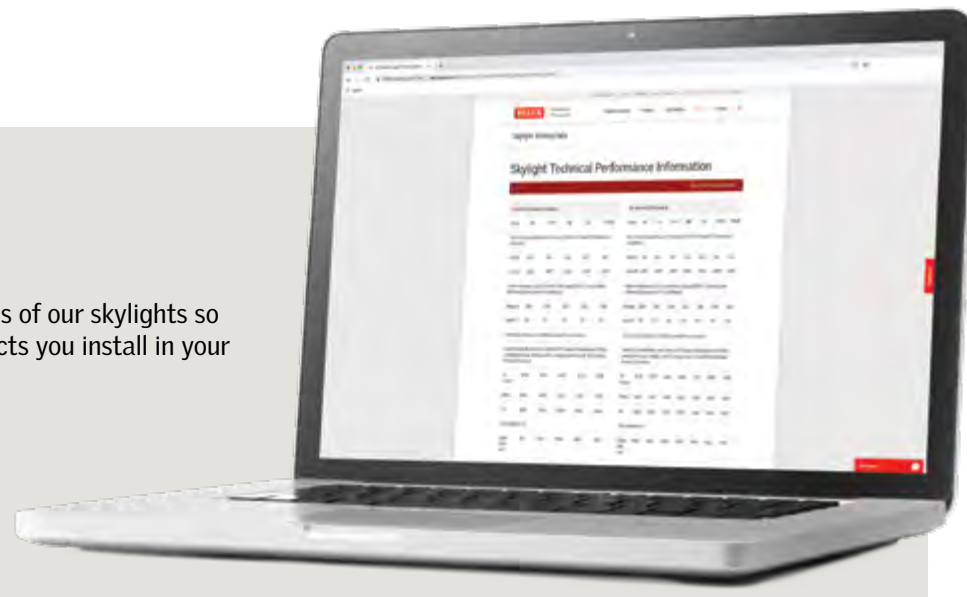

ENERGY STAR®

One of the most straightforward ways to help meet energy codes as a builder or architect, while still designing bright, airy buildings, is to specify ENERGY STAR® certified products.

Most VELUX residential products are ENERGY STAR® certified in all 50 states, which means they meet energy efficiency standards set by the US Environmental Protection Agency (EPA). In order to be ENERGY STAR® certified, fenestration products must have their U-factor, Visible Transmittance, and Solar Heat Gain Coefficient ratings independently tested and approved under the FenStar™ Certification Program of the National Fenestration Rating Council (NFRC) to qualify.

By using ENERGY STAR® certified products, architects and builders can use skylights to bring much needed daylight and fresh air inside, allowing them to create more attractive buildings and more livable spaces while still meeting local energy codes.

In warmer climates, there is great potential for lighting energy savings by using emerging control technologies like VELUX ACTIVE or more effective daylighting products like VELUX skylights with blinds and Sun Tunnel® Skylights.



¹ For the most up-to-date Federal Solar Tax Credit information, visit veluxusa.com/go-solar.

² To qualify for the VELUX 10-year installation warranty, VELUX flashing must be purchased. The 10-year installation warranty excludes EVMS, EV, QPF, EF.

³ VELUX blinds are not available for any VELUX custom-sized skylights. VELUX blinds when purchased with a standard size accessory tray are available for select E-Class skylights.

Code Compliance

VELUX offers a broad array of skylights, roof windows, and sun tunnels that meet the applicable performance requirements and testing and labeling standards written into the most current US Model Codes:

- 2018 IBC (International Building Code)
- 2018 IRC (International Residential Code), and
- 2018 IECC (International Energy Conservation Code),
- As well as local and regional codes based on the above codes.

Additionally, electrical components built into VELUX products are UL listed.

Standard VELUX residential skylights and sun tunnel products also meet or exceed applicable Powersmart requirements, in addition to those of the current and prior North American Fenestration Standards (NAFS), also known as AAMA/WDMA/CSA 101/I.S.2/A440. Copper-clad versions may not exceed these requirements but do meet other standards required of them.

To verify these attainments on-site, the products are shipped with all required labels to expedite the inspection and final acceptance process. VELUX confidently certifies through these labels that only products consistent with the tested specimens are sent to the job.

Warranty

For over 75 years, VELUX has been dedicated to producing skylights that are synonymous with quality and reliability. Our commitment to you does not end once your skylight is installed.

The VELUX deck- and curb-mounted product family is designated as "The No Leak Skylight." It carries a 10-year installation warranty, plus 20 years on glass seal failure, 10 years on product, and 5 years on blinds and controls.

This limited warranty does not apply to VELUX products purchased prior to January 1, 2010.

NOTICE: ALL GLASS MAY BE SUBJECT TO UNEXPECTED AND SPONTANEOUS BREAKAGE in rare circumstances due to imperfections in the glass that are undetectable during the manufacturing and inspection process by the manufacturer of the glass and VELUX.

VELUX offers the choice of laminated or tempered glass skylights. Impact glass and comfortplus glass are all types of laminated glass. Comfort glass is a type of tempered glass. Laminated glass is a combination of two or more glass sheets with one or more interlayers of plastic (PVB) or resin. In case of breakage, the interlayer is designed to hold the fragments together. Tempered glass does not contain an interlayer to hold the fragments together. Instead, tempered glass is designed to break into small, pebble-like pieces. When tempered glass breaks, pieces of glass come loose and may strike an individual.

CONSULT LOCAL REGULATIONS AND/OR BUILDING MATERIAL CONSULTANTS TO DETERMINE WHICH TYPE OF GLASS IS RIGHT FOR YOU OR IF LAMINATED GLASS IS REQUIRED IN YOUR APPLICATION.

All VELUX skylights, roof windows, Sun Tunnel® Skylights, flashing kits and blinds must be purchased through a qualified VELUX dealer. Please see the "Where To Buy" section of veluxusa.com website for a list of VELUX dealers near you.

The VELUX Group creates better living environments with daylight and fresh air through the roof. The VELUX product program contains a wide range of roof windows and skylights, along with solutions for flat roofs. The Group also supplies many types of decoration and sun screening, roller shutters, installation products, and products for remote control for installation in roofs. The VELUX Group, which has manufacturing companies in 11 countries and sales companies in nearly 40 countries, represents one of the strongest brands in the global building materials sector and its products are sold in most parts of the world. The VELUX Group has about 10,000 employees and is owned by VKR Holding A/S, a limited company wholly owned by foundations and family. For more details, visit velux.com.

VELUX America LLC
450 Old Brickyard Road
PO Box 5001
Greenwood, SC 29648-5001
Tel 1-800-888-3589
Fax 1-864-943-2631

Bringing light to life™

VELUX®

XUS 20183-0120 • ©2020 VELUX Group • VELUX®, VELUX logo are registered trademarks • VELUX Sun Tunnel is a trademark of VELUX Group. HGTV, HGTV Smart Home, HGTV Smart Home Giveaway, HGTV Urban Oasis, HGTV Urban Oasis Giveaway and their associated logos are trademarks of Scripps Networks, LLC. Used with permission; all rights reserved.